

S2ABF thru S2MBF

Surface Mount Glass Passivated Junction Rectifiers Reverse Voltage 50 to 1000V Forward Current 2.0A

FEATURES

- * Plastic package has Underwriters Laboratory Flammability Classification 94V-0
- * High temperature metallurgically bonded construction
- * Cavity-free glass passivated junction
- * Capable of meeting environmental standards of MIL-S-19500
- * 2.0 A operation at $T_c=75^{\circ}\text{C}$ with no thermal runaway
- * Typical IR less than $1.0\mu\text{A}$
- * High temperature soldering guaranteed: $260^{\circ}\text{C}/10$ seconds

Terminals: Plated leads, solderable per

Case: JEDEC SMB-FL, molded plastic over glass Die

Terminals: Plated leads, solderable per MIL-STD-750, Method 2026

Polarity: Color band denotes cathode end

Mounting Position: Any

Weight: 0.066 gram

Handling precaution: None

Electrical Characteristic

1. Maximum & Thermal Characteristics Ratings at 25°C ambient temperature unless otherwise specified.

Parameter Symbol	symbol	S2ABF	S2BBF	S2DBF	S2GBF	S2JBF	S2KBF	S2MBF	Unit
Device marking code		S2A	S2B	S2D	S2G	S2J	S2K	S2M	
Maximum repetitive peak reverse voltage	V_{RRM}	50	100	200	400	600	800	1000	V
Maximum RMS voltage	V_{RMS}	35	70	140	280	420	560	700	V
Maximum DC blocking voltage	V_{DC}	50	100	200	400	600	800	1000	V
Maximum average forward rectified current 0.375" (9.5mm) lead length at $T_c = 75^{\circ}\text{C}$	$I_{F(AV)}$	2.0							A
Peak forward surge current 8.3ms single half sine-wave superimposed on rated load (JEDEC Method)	I_{FSM}	50							A
Typical thermal resistance (Note 1)	$R_{\theta JA}$ $R_{\theta JC}$	135 25							$^{\circ}\text{C}/\text{W}$
Operating junction and storage temperature range	TJ, TSTG	-50 to +150							$^{\circ}\text{C}$

Electrical Characteristics Ratings at 25°C ambient temperature unless otherwise specified.

Parameter Symbol	symbol	S2ABF	S2BBF	S2DBF	S2GBF	S2JBF	S2KBF	S2MBF	Unit
Maximum instantaneous forward voltage at 2.0A	V_F	1.1							V
Maximum DC reverse current $T_A = 25^{\circ}\text{C}$ at rated DC blocking voltage $T_J = 125^{\circ}\text{C}$	IR	5.0 100							μA
Typical junction capacitance at 4.0V, 1MHz	CJ	30.0							PF

NOTES:

1. 8.0mm^2 (.013mm thick) land areas

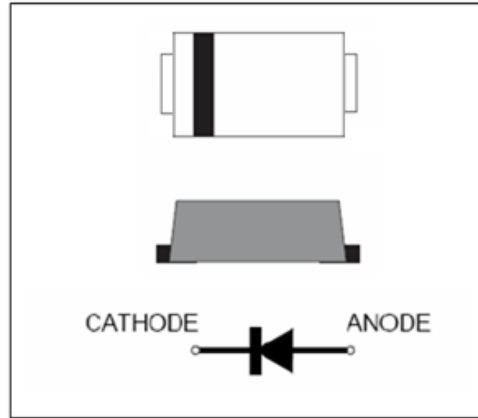

we declare that the material of product is halogen free (green epoxy compound).

S2ABF thru S2MBF

2. Ratings and Characteristic Curves (TA = 25°C unless otherwise noted)

Fig. 1 - Forward Current Derating Curve

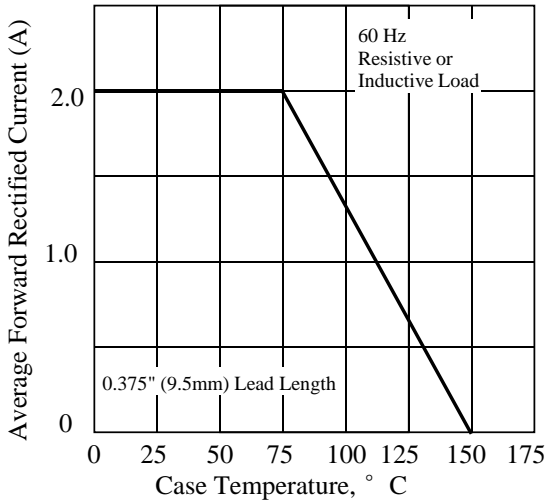

Fig. 2 - Maximum Non-repetitive Peak Forward Surge Current

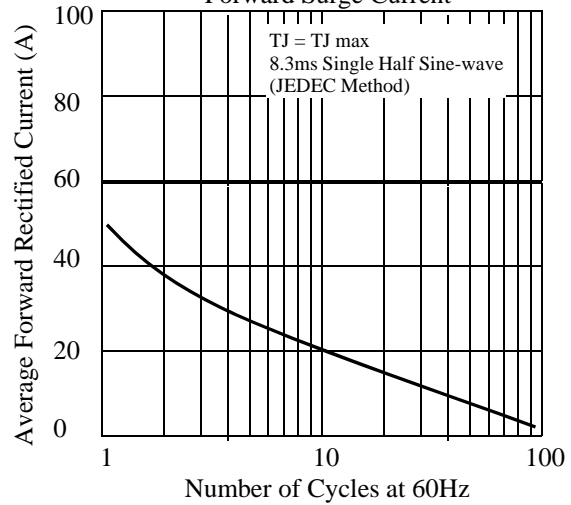

Fig 3. - Typical Instantaneous Forward Characteristics

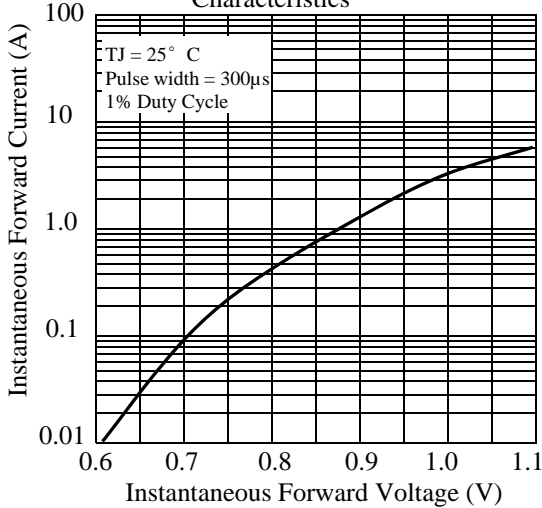

Fig 4. - Typical Reverse Characteristics

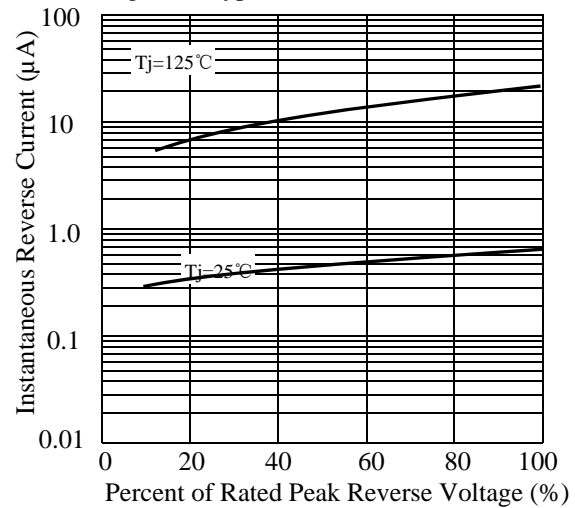

Fig 5. - typical transient thermal impedance

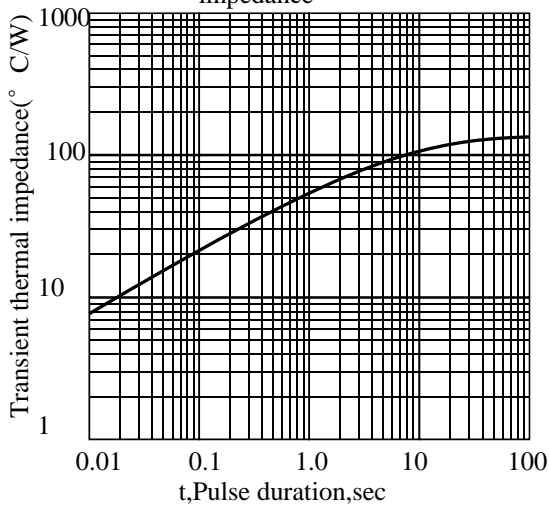
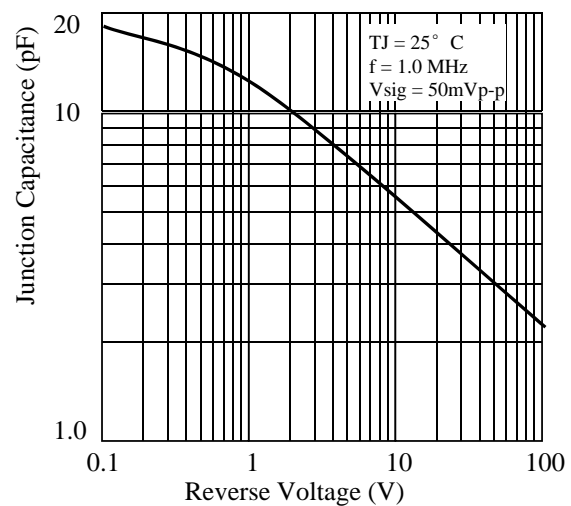

Fig 6. - Typical Junction Capacitance



S2ABF thru S2MBF

3. dimension:

SMB-FL

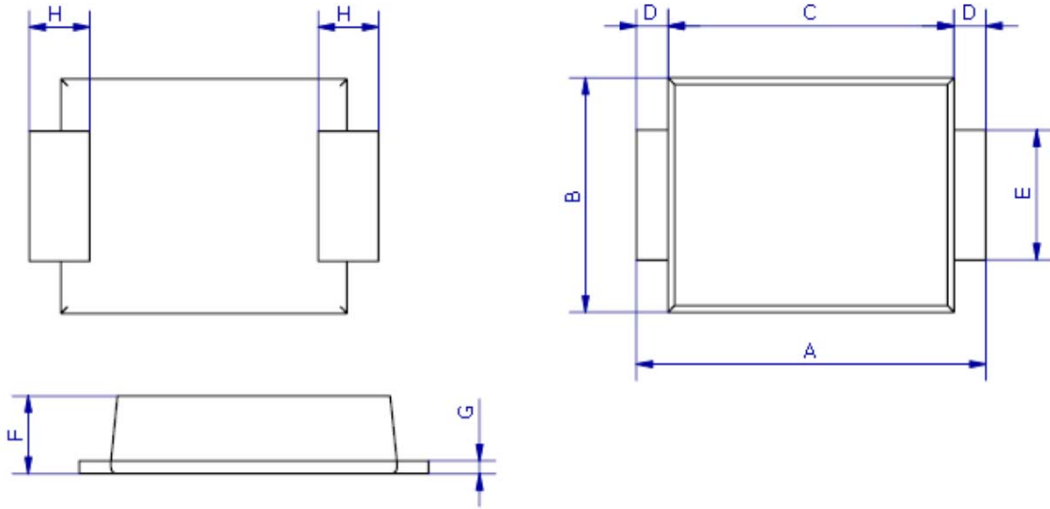

DIM	MILLIMETERS		INCHES	
	MIN	MAX	MIN	MAX
A	5.3	5.7	0.209	0.224
B	3.4	3.8	0.134	0.150
C	4.3	4.7	0.169	0.185
D	0.45Typ		0.018Typ	
E	1.9	2.1	0.0748	0.08268
F	1.05	1.40	0.04134	0.05512
G	0.2	0.3	0.00591	0.00984
H	0.95Typ		0.037Typ	

Mounting Pad Layout

--- SMB-FL

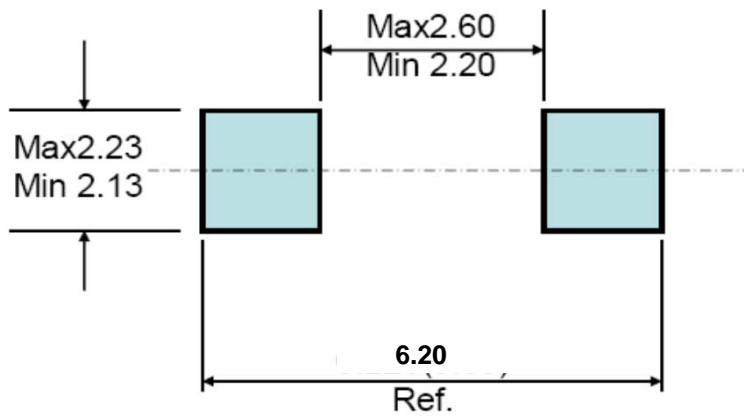

S2ABF thru S2MBF

4. Update Record

版次	更新记录	更新作者	更新日期
1	第一版	周杰	2014.04.30