

HSF

NOTES:

Current Rating: 0.5AMP
 Contact Resistance: 35mΩ Max
 Withstand Voltage: 500V AC/DC
 Insulation Resistance: 500MΩ Min
 Operation Temperature: -65°C to +125°C

Contact Material: Phosphor Bronze
 Contact plating: Au Or Sn over Ni
 Insulator Material: PBT+30%G.F UL94V-0

Ordering Information

6322D-XXX S I XX PN A 01

No. of Pins	Contact Plating	Packing
26 50	S1=3u"Gold/Tin	A=Tray
34 60	S3=10u"Gold/Tin	T=Tube
40 68	S4=15u"Gold/Tin	
	S5=30u"Gold/Tin	

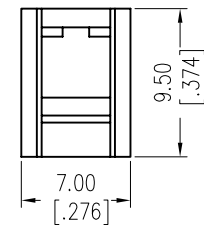
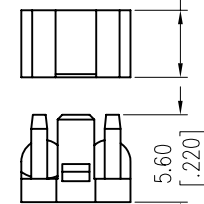
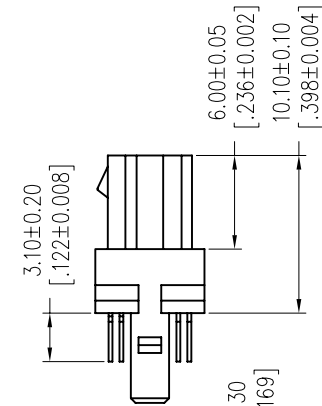
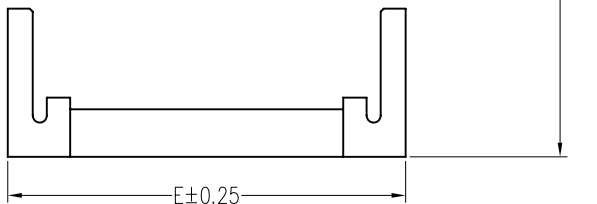
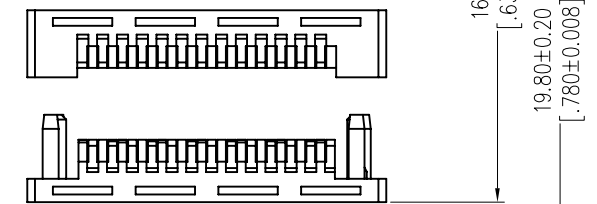
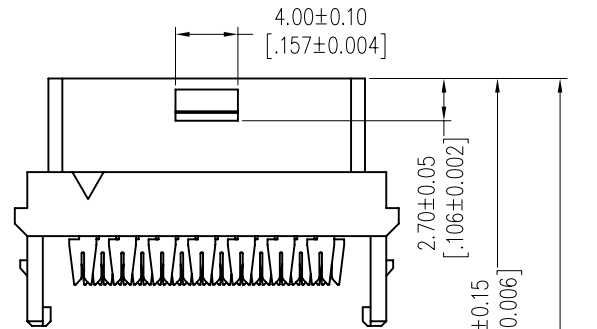
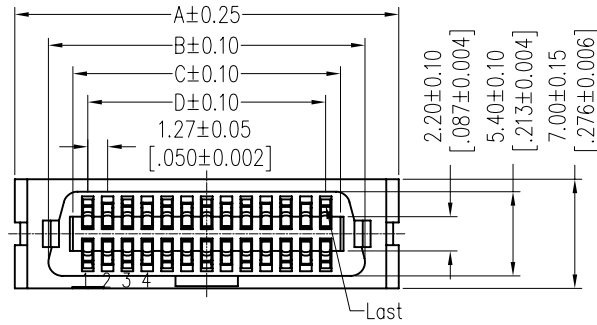

No. of Pins	Dimension				
	A	B	C	D	E
26	24.60	20.29	17.14	15.24	25.49
34	29.68	25.37	22.22	20.32	30.57
40	33.49	29.18	26.03	24.13	34.38
50	39.84	35.53	32.38	30.48	40.73
60	46.19	41.88	38.73	36.83	47.08
68	51.27	46.96	43.81	41.91	52.16

Item	Pitch	Mating
Standard	1.27	6320D
Alternate		

REV	DATE	MODIFICATION DESCRIPTION	CHANGE	OPERATION	DRAW	DATE	SCALE	FIT	PART NO.
				x.x ±0.40	JYHuang	2012/11/13	UNIT	mm	6322D-XXXSIXXPN A01
				x.xx ±0.25	CHECK	DATE	SIZE	A4	
A0	2012/11/13	NEW	-----	x.xxx ±0.15	APPROVE	DATE	SHEET	1/1	TITLE: 1.27mm SCSI SOCKET IDC TYPE CEN-TYPE, FOUR PARTS
				Angle ± 3'			PROJ.	Customer NO.	
				DIM TOL					